

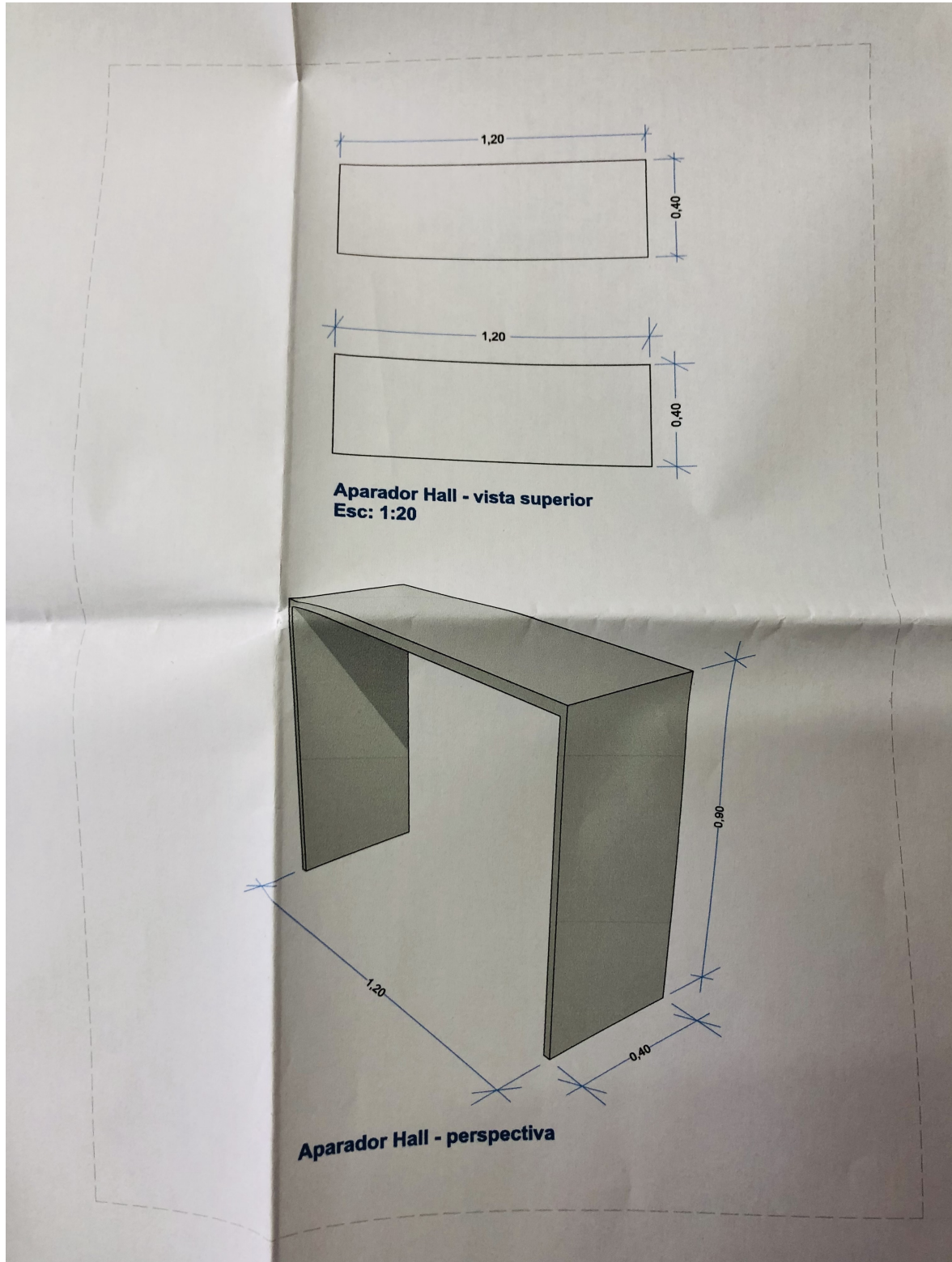

CÂMARA MUNICIPAL DE ARARAS

ESTADO DE SÃO PAULO





CÂMARA MUNICIPAL DE ARARAS

ESTADO DE SÃO PAULO

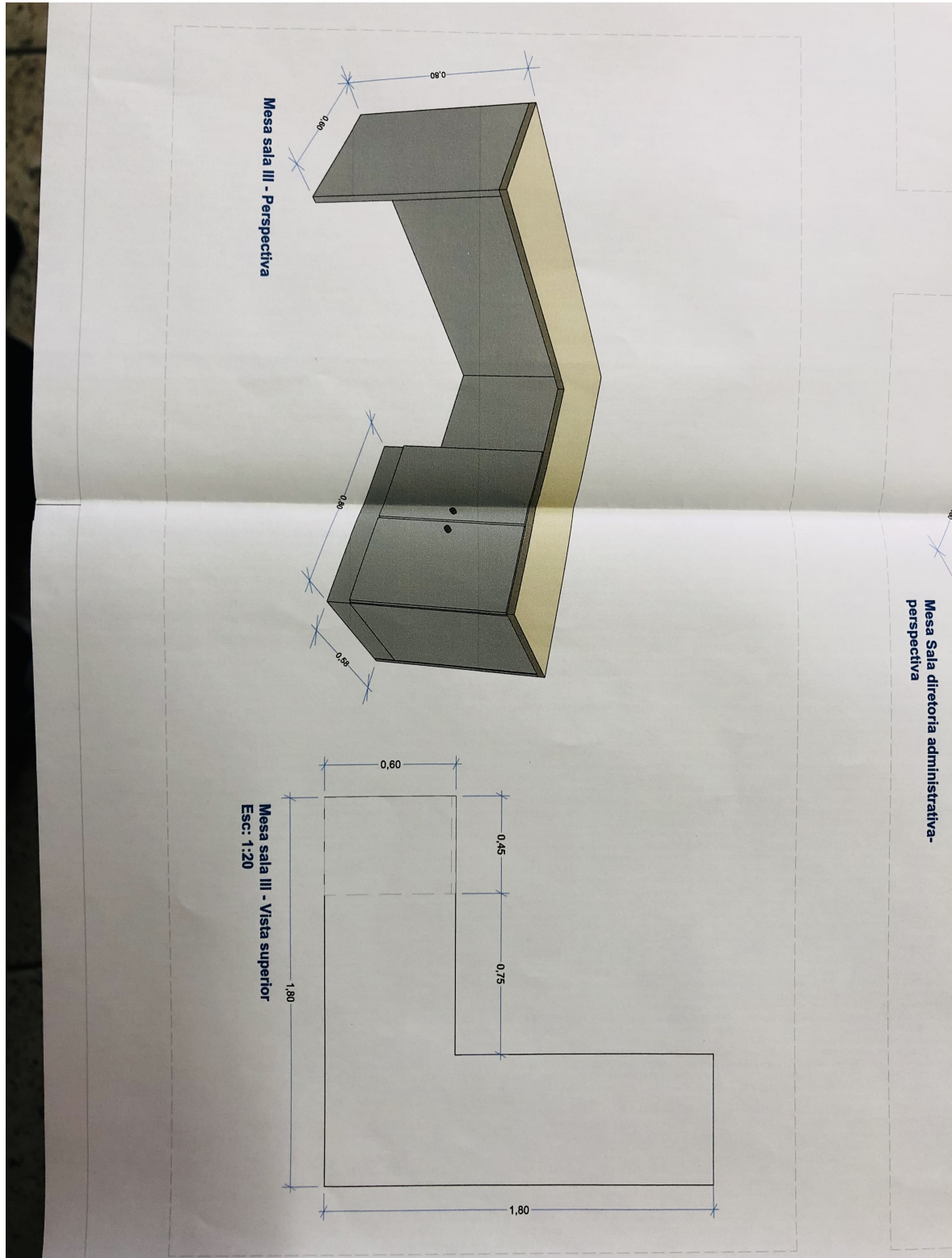



CÂMARA MUNICIPAL DE ARARAS

ESTADO DE SÃO PAULO

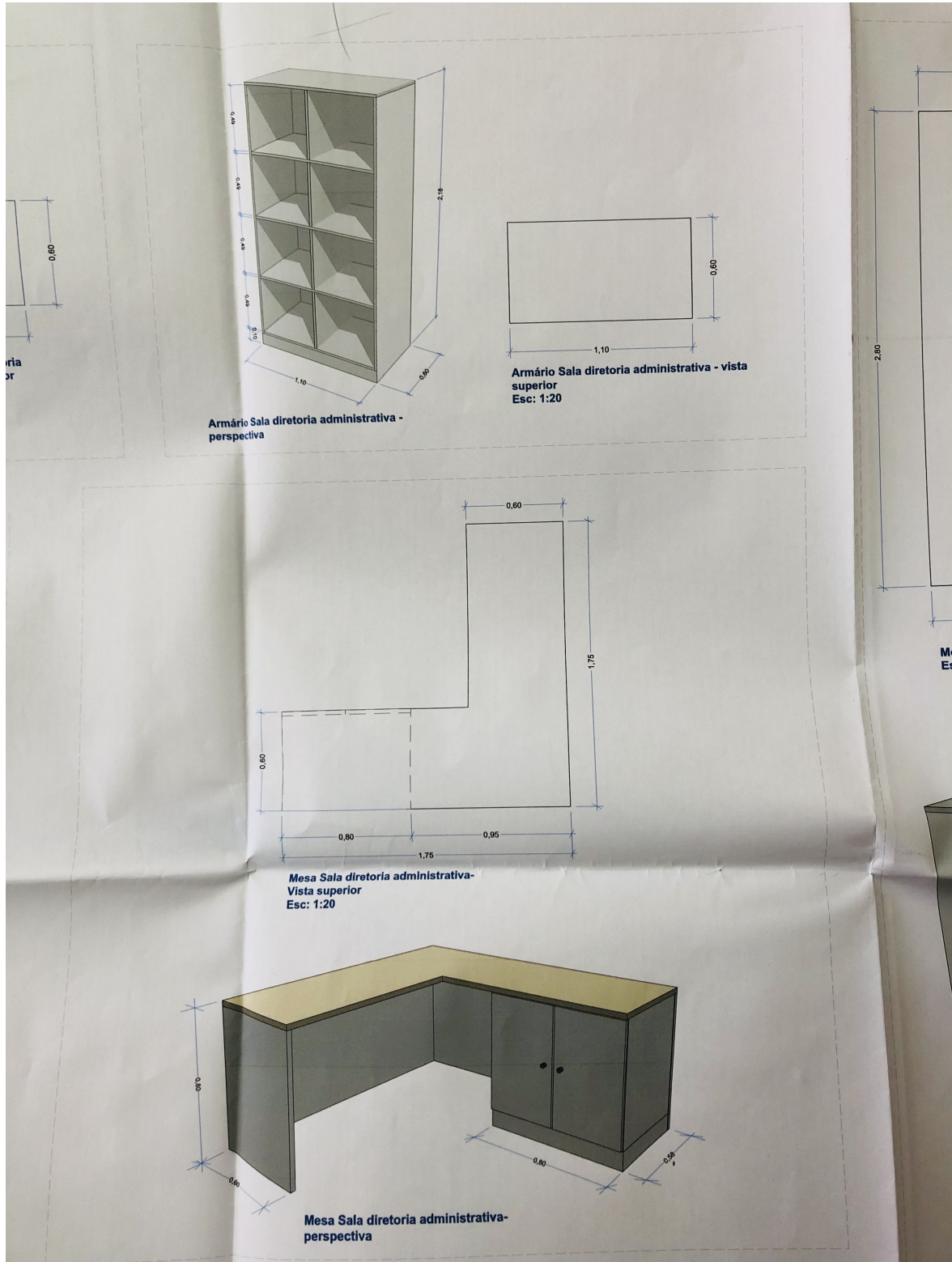



CÂMARA MUNICIPAL DE ARARAS

ESTADO DE SÃO PAULO

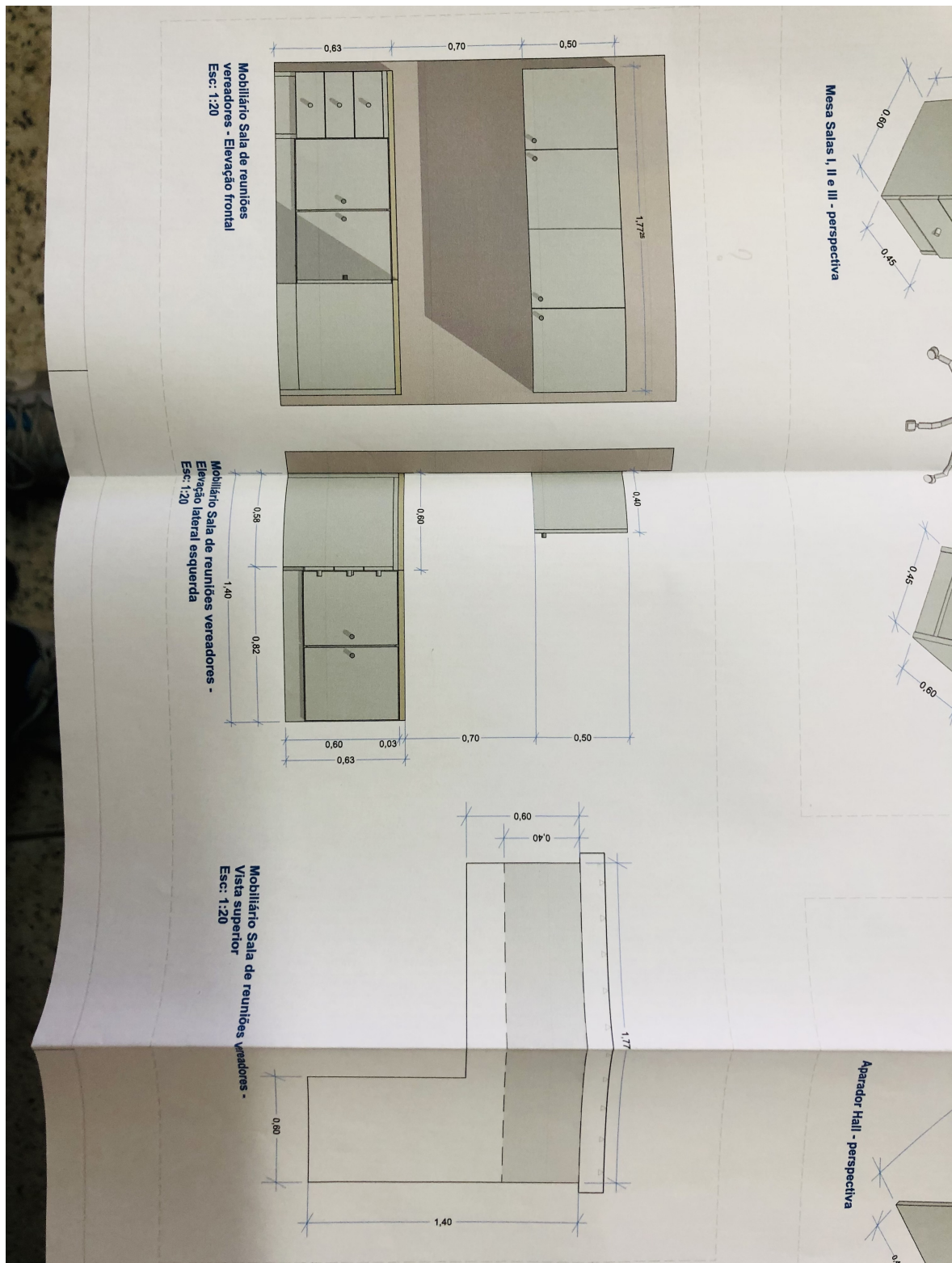



CÂMARA MUNICIPAL DE ARARAS

ESTADO DE SÃO PAULO

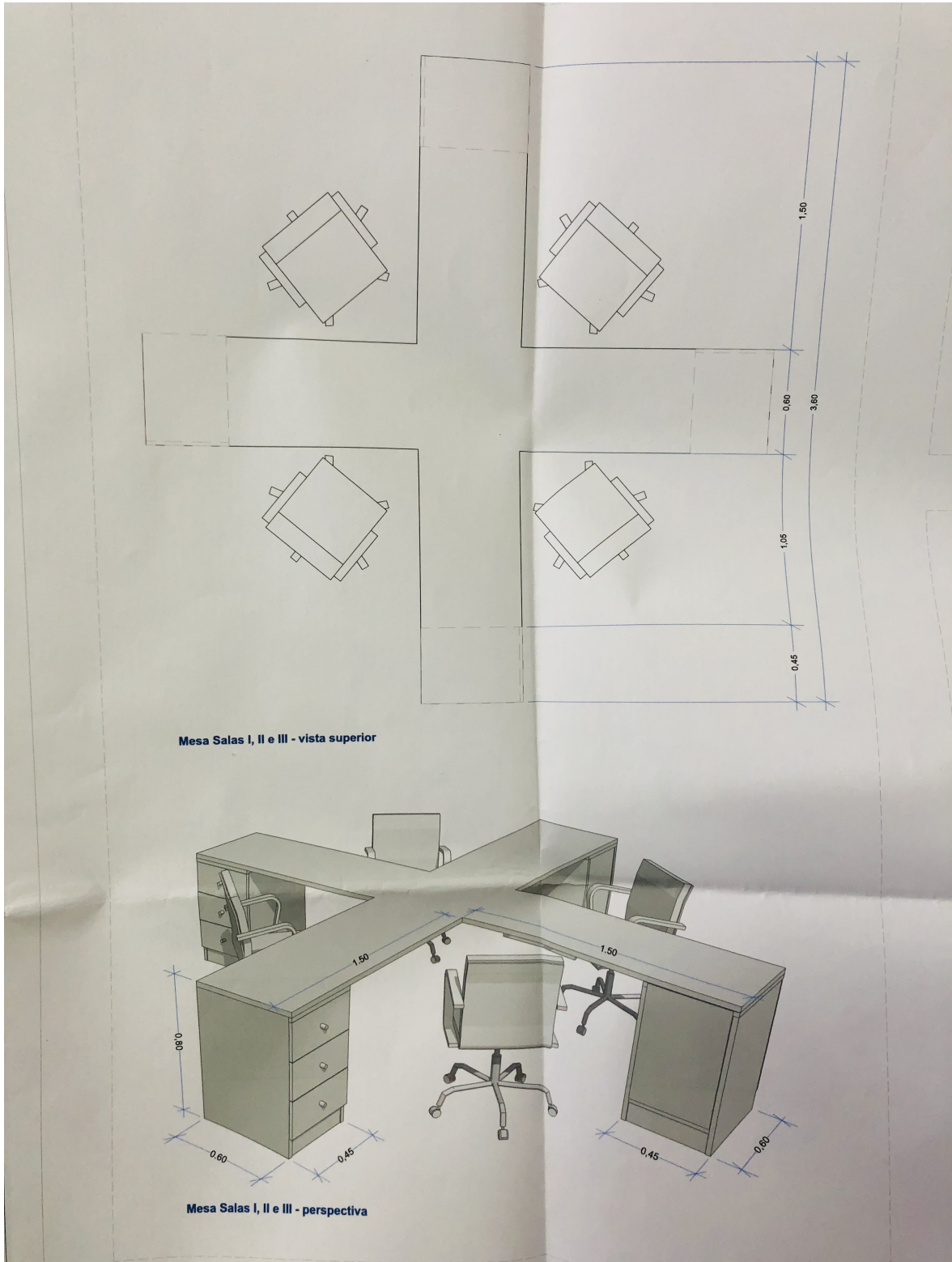



CÂMARA MUNICIPAL DE ARARAS

ESTADO DE SÃO PAULO

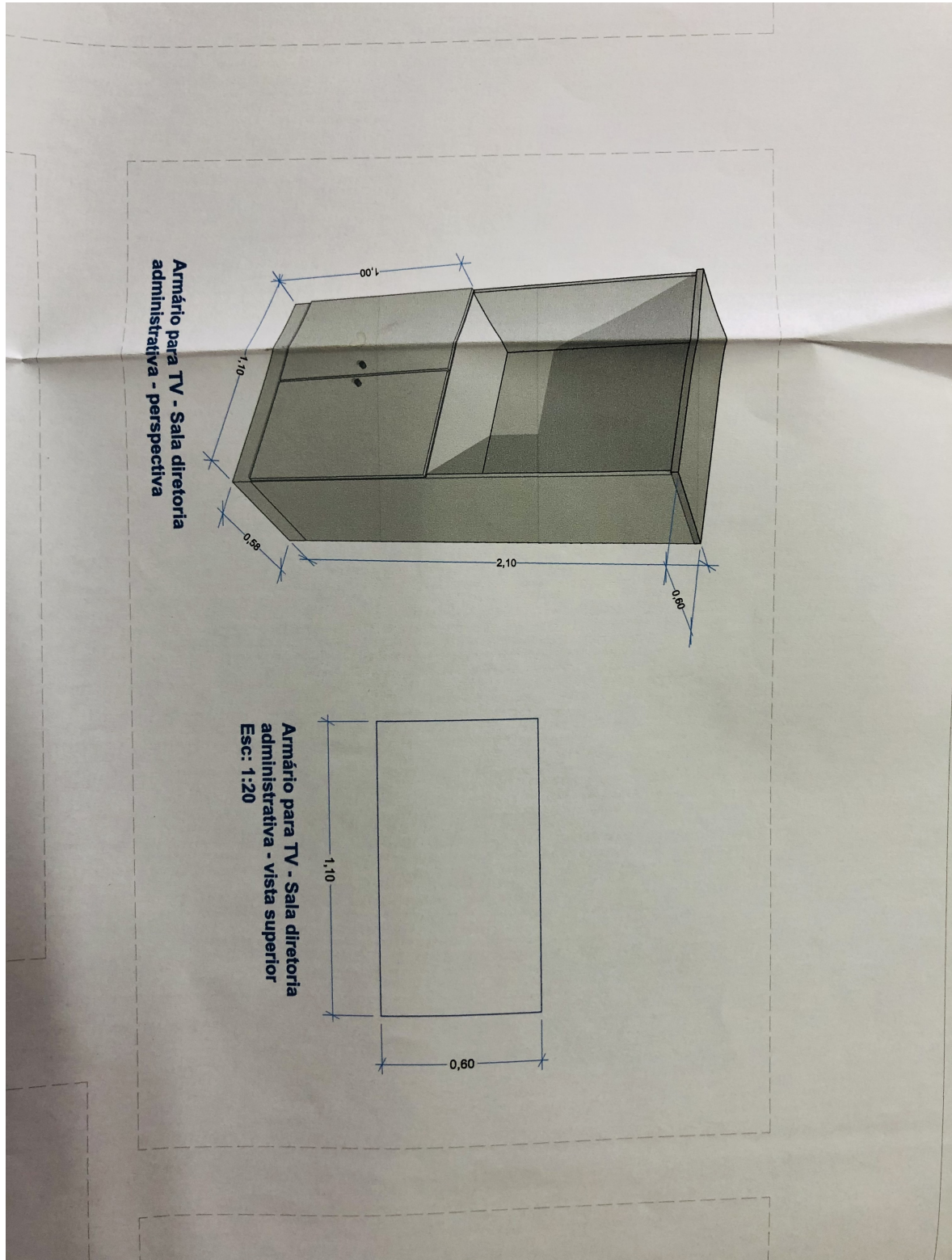



CÂMARA MUNICIPAL DE ARARAS

ESTADO DE SÃO PAULO



1,80

PREFEITURA DE ARARAS
PELO BEM DA PÁTRIA

ADMINISTRAÇÃO PEDRO ELISEU FILHO / ANETE MONTEIRO DOS SANTOS CASAGRANDE

OBJETO:
REFORMA CÂMARA MUNICIPAL DE ARARAS

LOCAL:
MUNICÍPIO DE ARARAS

TÍTULO:
MOBILIÁRIOS

MODIFICAÇÕES:	DATA:

SECRETARIA MUNICIPAL DE PLANEJAMENTO, GESTÃO E MOBILIDADE
planejamento@araras.gov.br - (19) 3547 3053

SECRETÁRIO: ARQUITETO FELIPE DEZOTTI BELOTO

DATA REVISÃO: _____

ESCALA: Indicada

FOLHA:
2/2



CÂMARA MUNICIPAL DE ARARAS

ESTADO DE SÃO PAULO

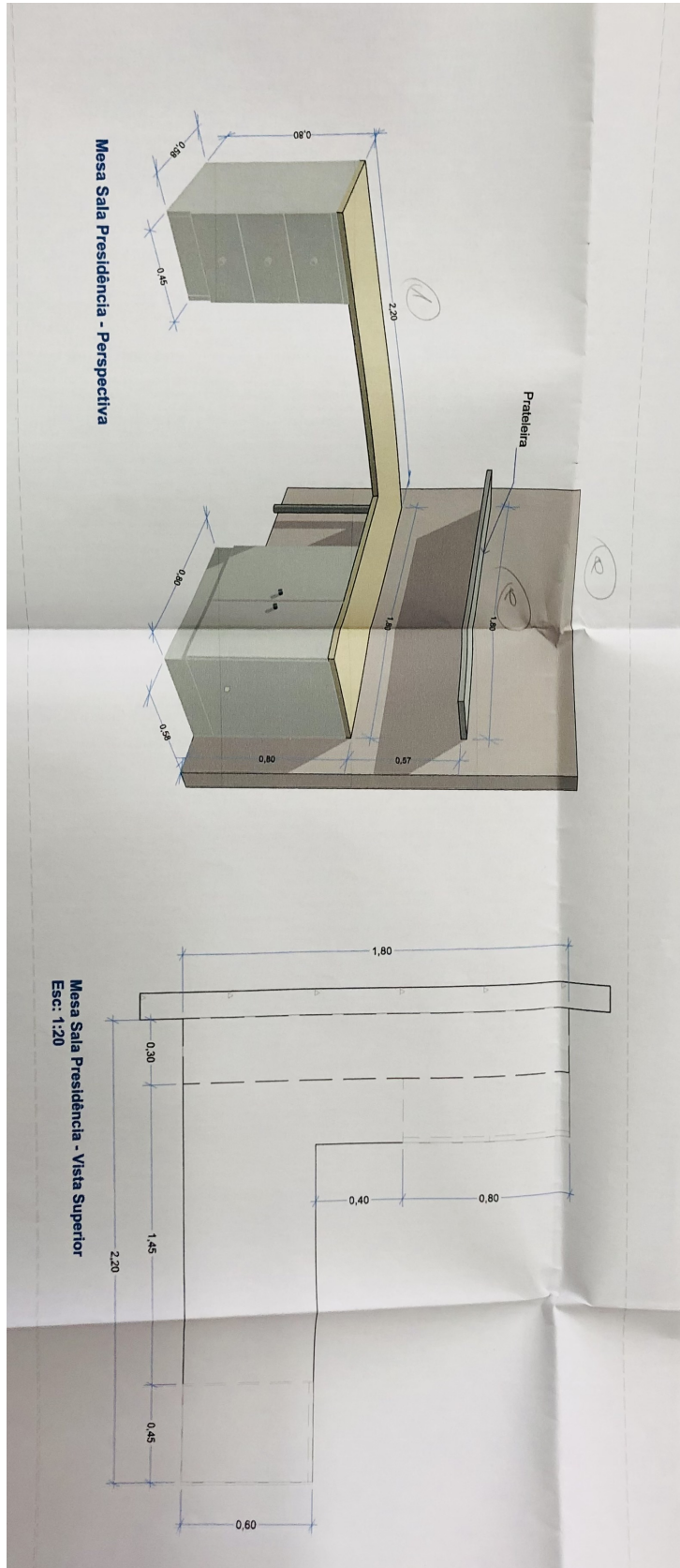



CÂMARA MUNICIPAL DE ARARAS

ESTADO DE SÃO PAULO

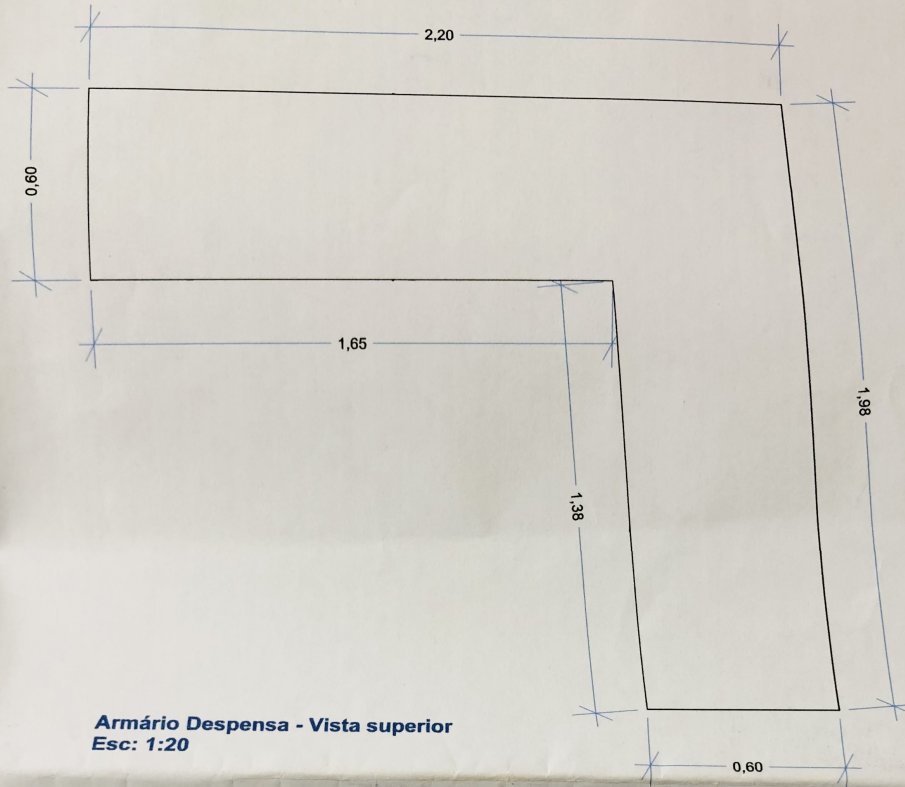

Armário Despensa - Vista superior
Esc: 1:20

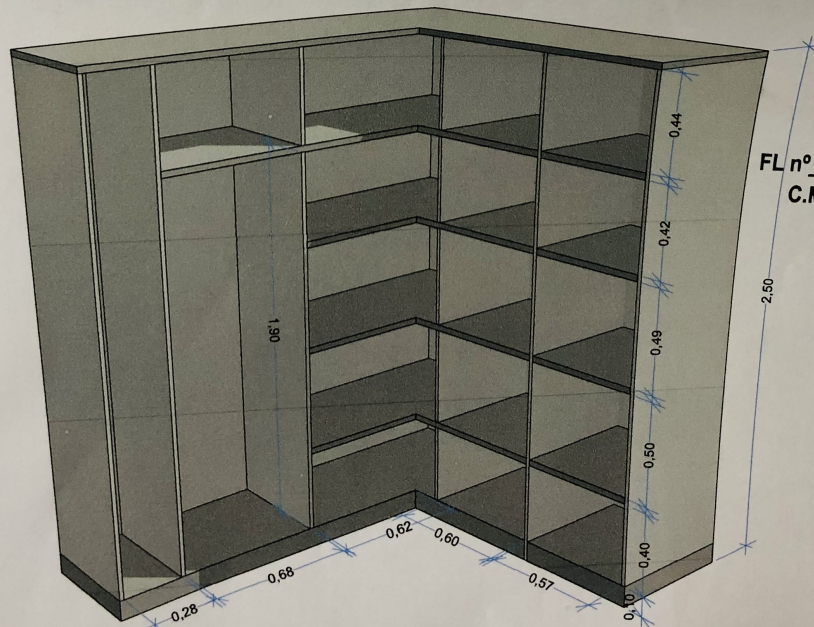

FL nº 06
C.M. ARARAS

Armário despensa - Perspectiva



CÂMARA MUNICIPAL DE ARARAS

ESTADO DE SÃO PAULO

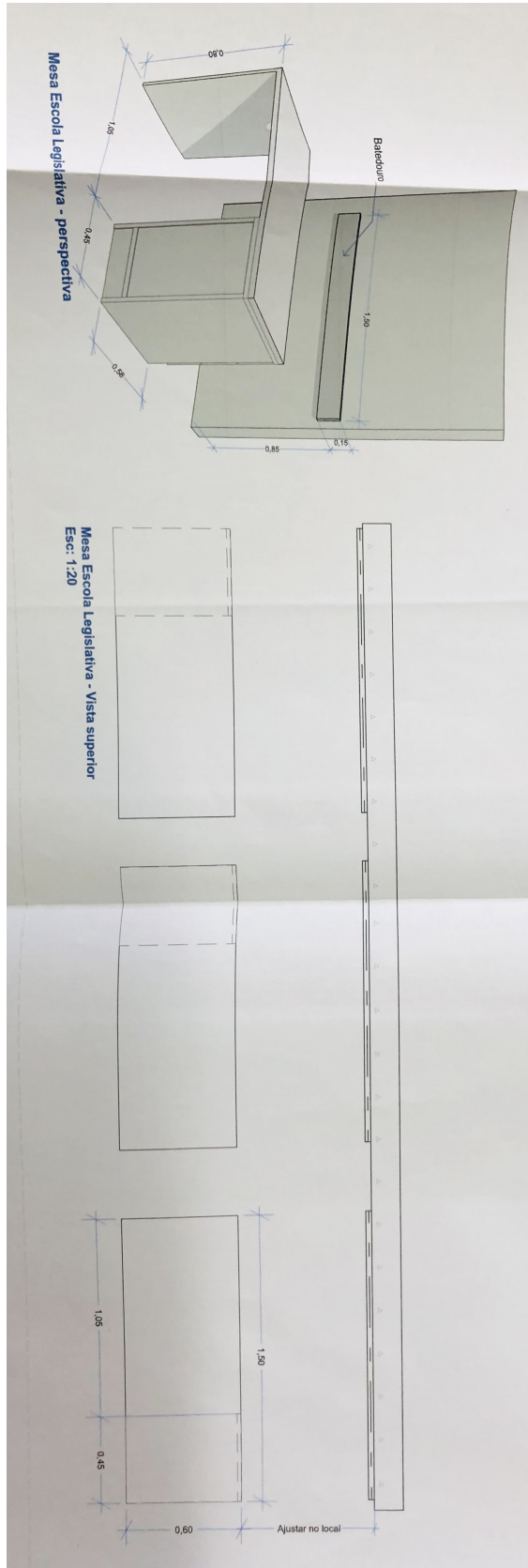



CÂMARA MUNICIPAL DE ARARAS

ESTADO DE SÃO PAULO

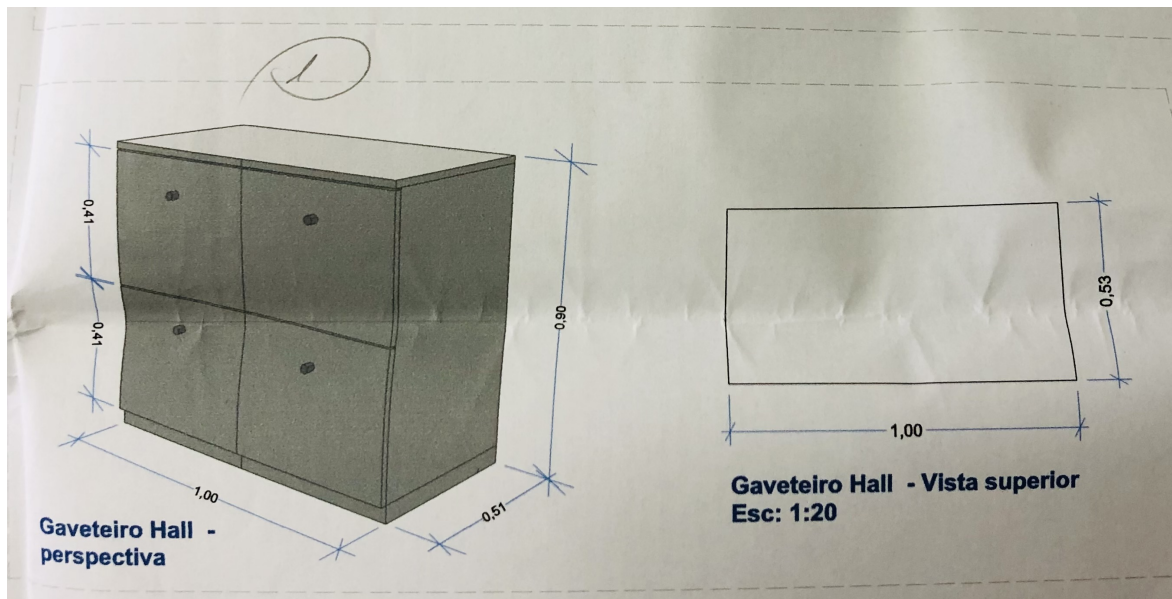



CÂMARA MUNICIPAL DE ARARAS

ESTADO DE SÃO PAULO

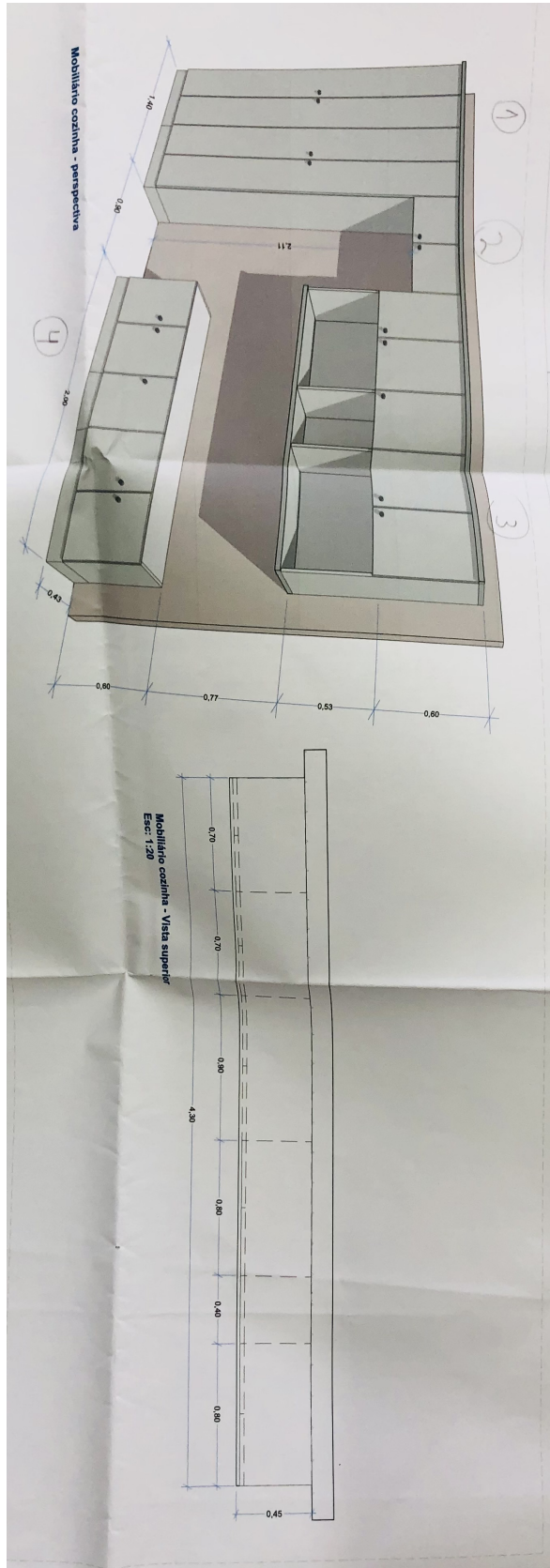



CÂMARA MUNICIPAL DE ARARAS

ESTADO DE SÃO PAULO

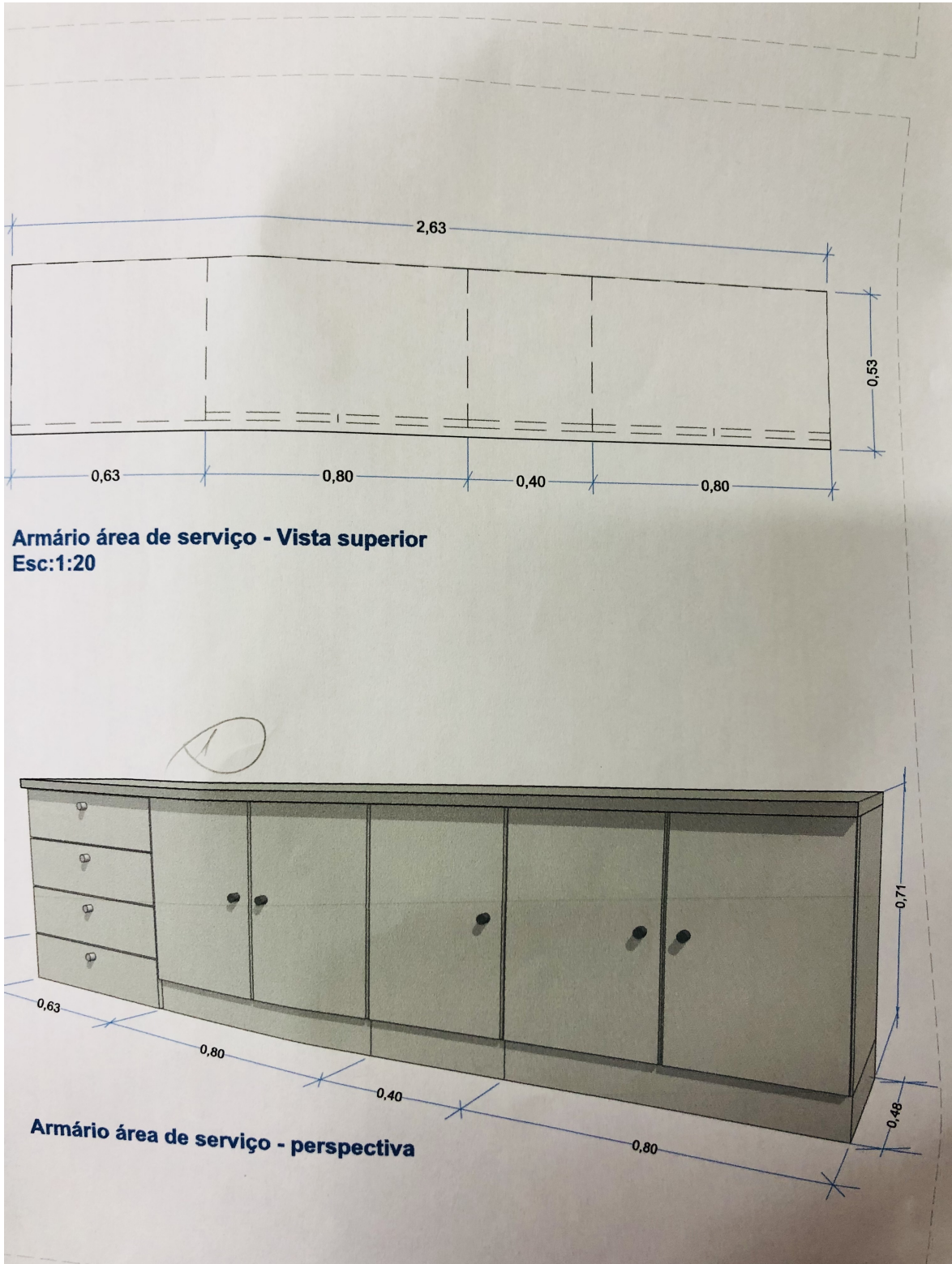



CÂMARA MUNICIPAL DE ARARAS

ESTADO DE SÃO PAULO



Mesa cozinha - Elevação frontal
Esc: 1:20

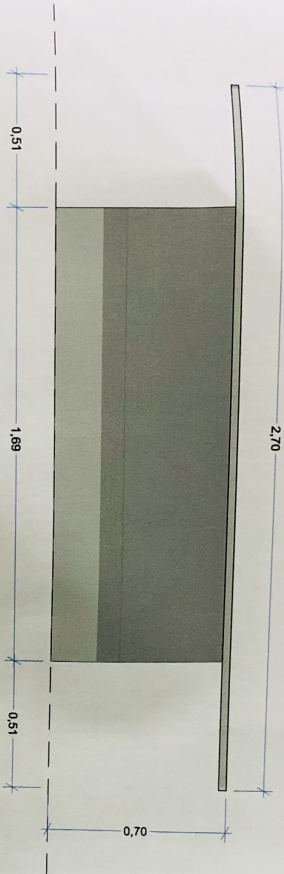

Mesa cozinha - vista superior
Esc: 1:20

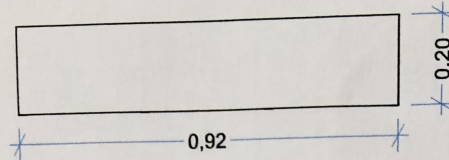
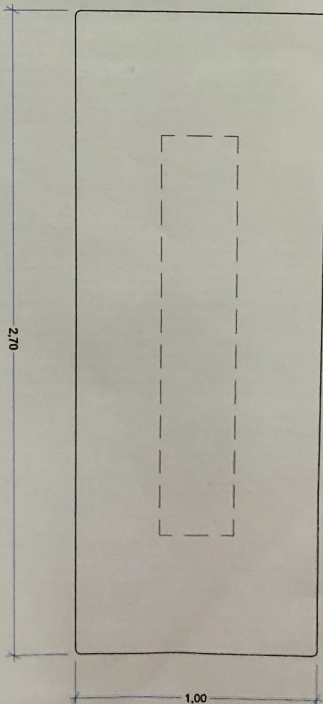

Nichos Sala Presidência
- Vista Superior
Esc: 1:20

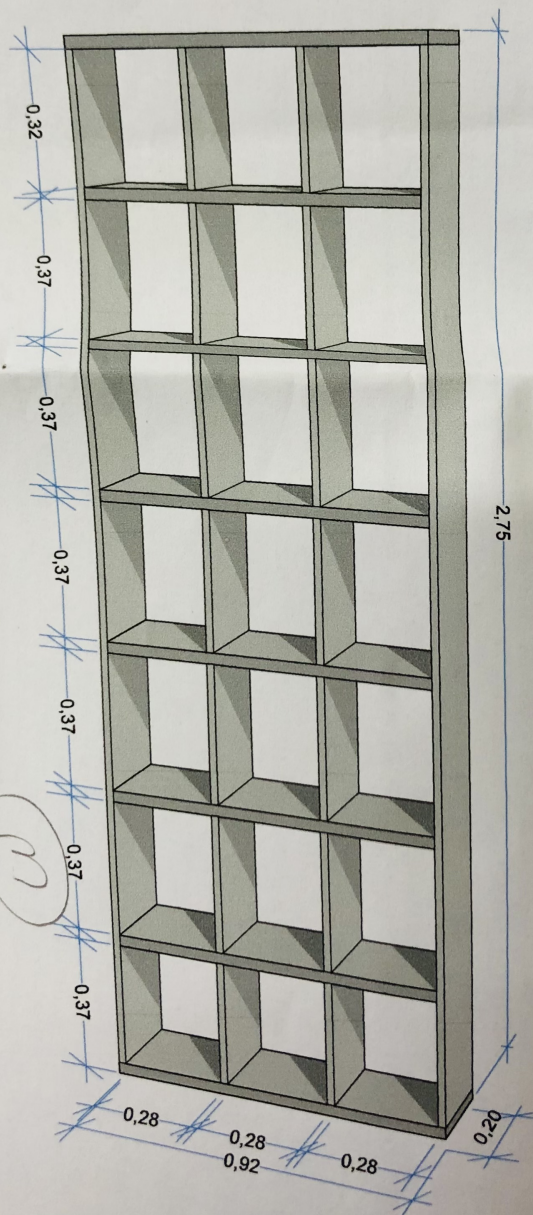

Nichos Sala Presidência
- Perspectiva



CÂMARA MUNICIPAL DE ARARAS

ESTADO DE SÃO PAULO

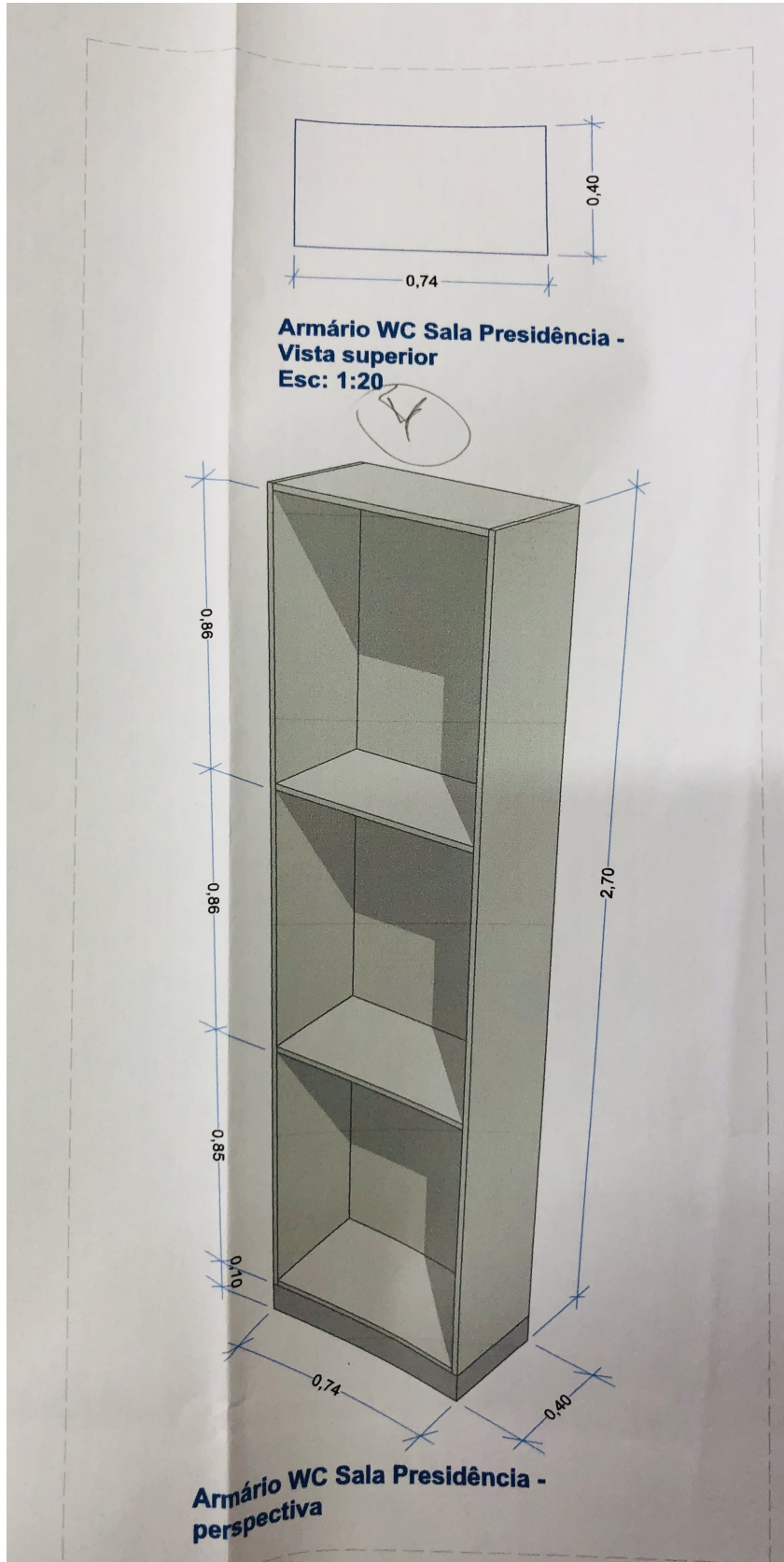



CÂMARA MUNICIPAL DE ARARAS

ESTADO DE SÃO PAULO

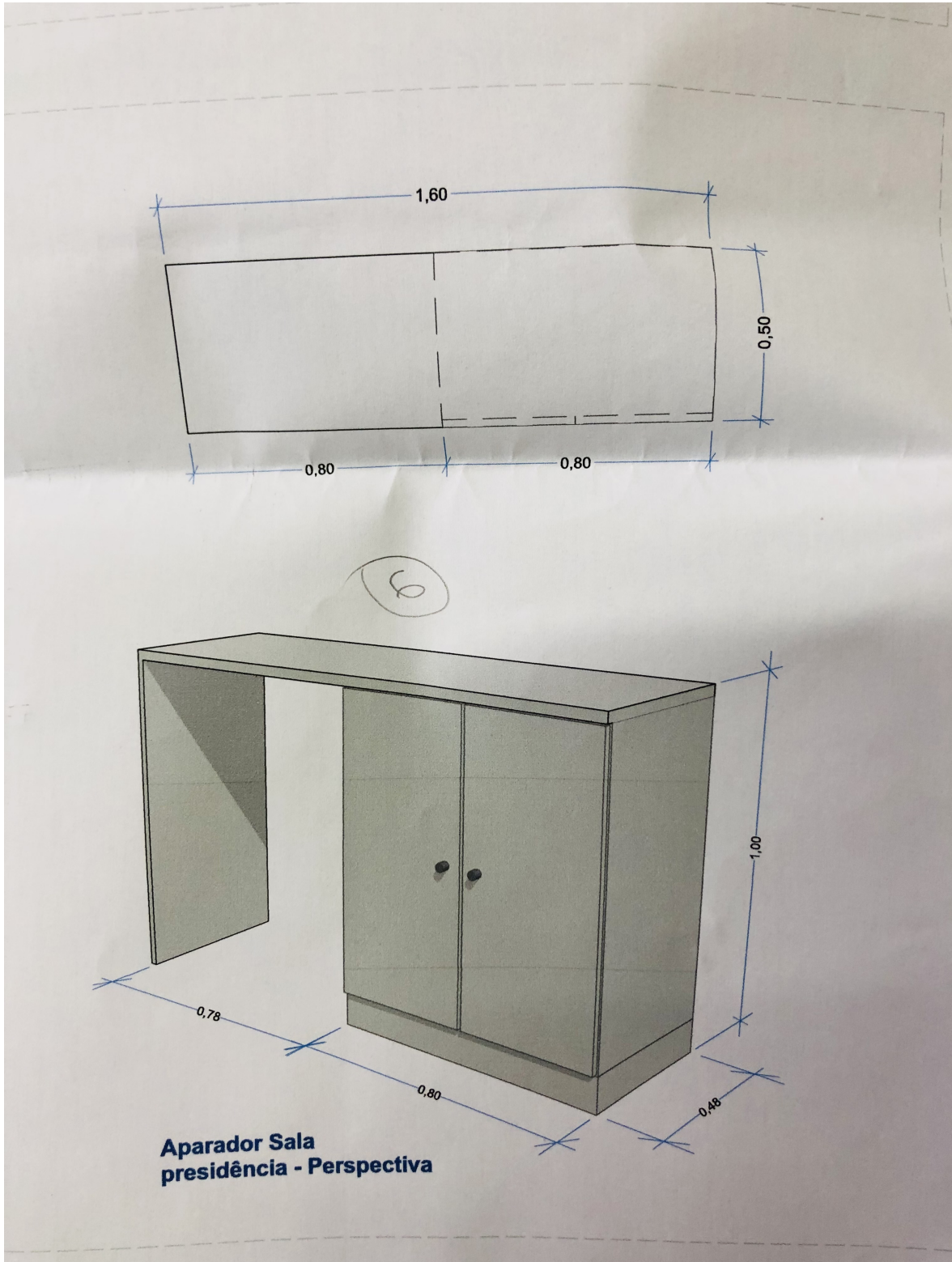



CÂMARA MUNICIPAL DE ARARAS

ESTADO DE SÃO PAULO

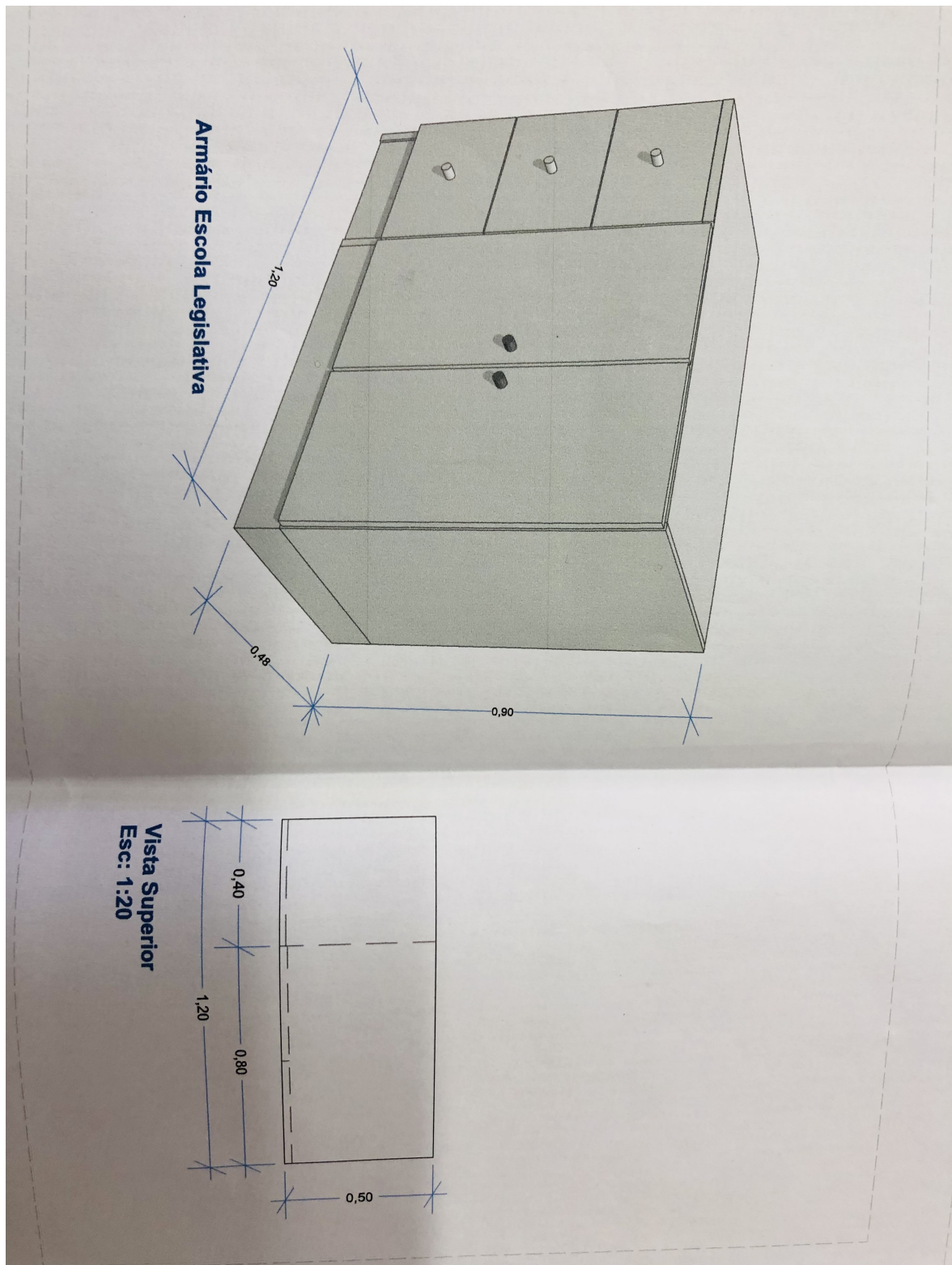



CÂMARA MUNICIPAL DE ARARAS

ESTADO DE SÃO PAULO

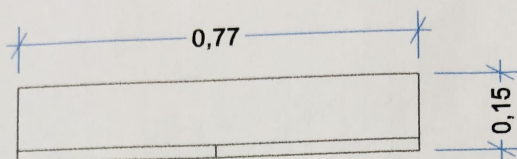

**Armário suspenso WC Sala
Presidência - Vista superior
Esc: 1:20**

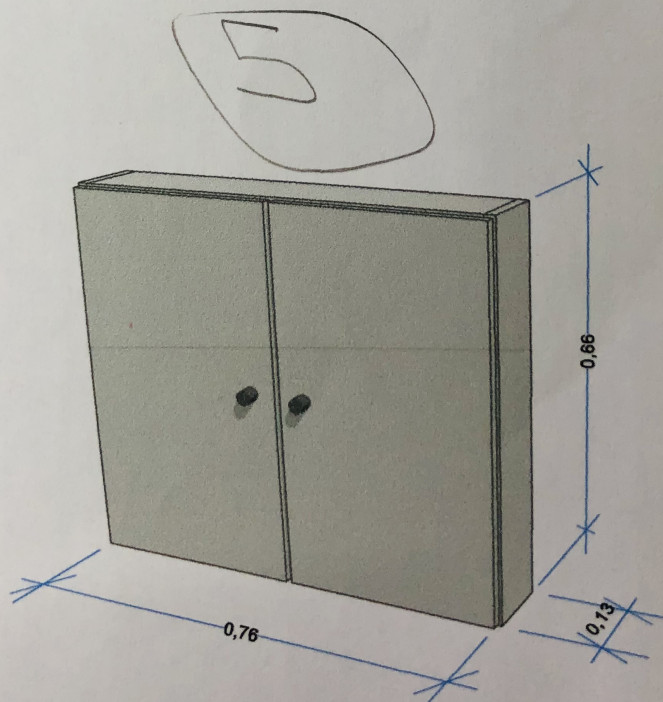

**Armário suspenso WC Sala
Presidência - perspectiva**



CÂMARA MUNICIPAL DE ARARAS

ESTADO DE SÃO PAULO

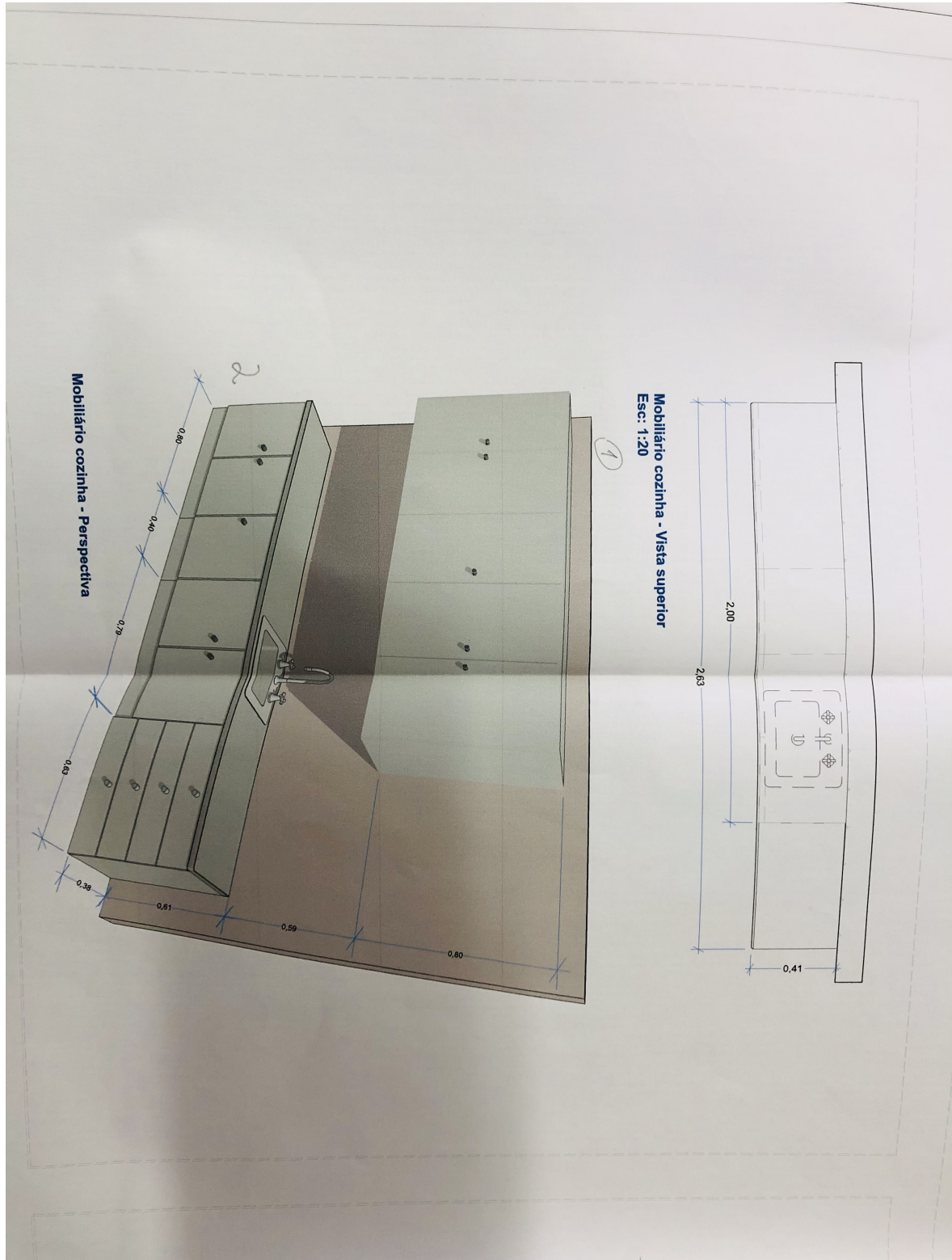



CÂMARA MUNICIPAL DE ARARAS

ESTADO DE SÃO PAULO

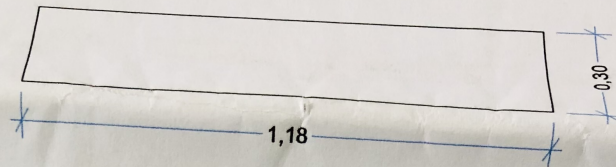

Armário Despensa - Vista superior
Esc: 1:20

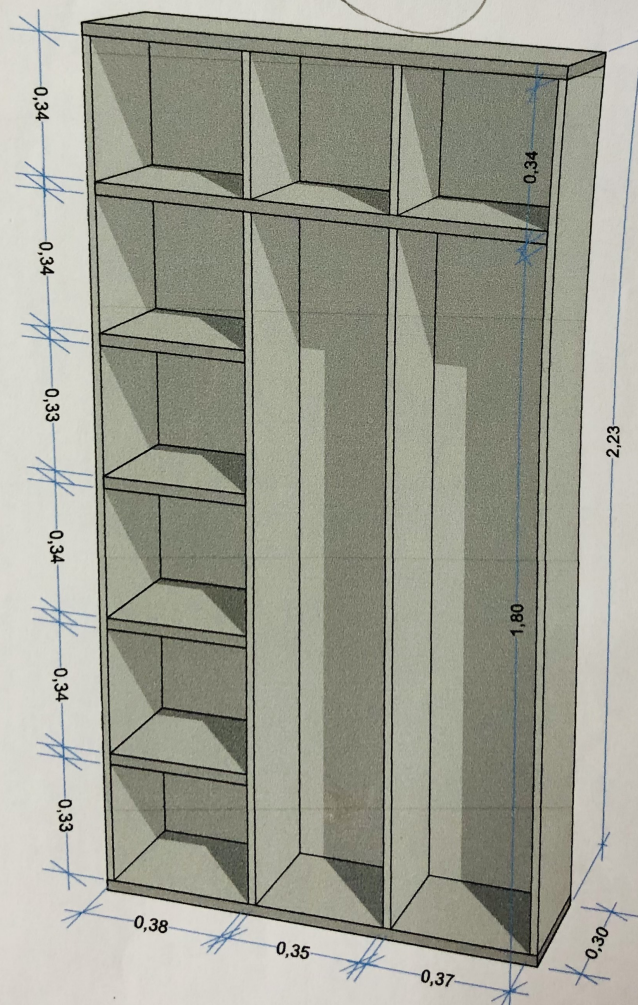

Armário Despensa - perspectiva



CÂMARA MUNICIPAL DE ARARAS

ESTADO DE SÃO PAULO



PREFEITURA DE ARARAS

ADMINISTRAÇÃO PEDRO ELISEU FILHO / ANETE MONTEIRO DOS SANTOS CASAGRANDE

OBJETO:
REFORMA CÂMARA MUNICIPAL DE ARARAS

LOCAL:
MUNICÍPIO DE ARARAS

TÍTULO:
MOBILIÁRIOS

MODIFICAÇÕES:	DATA:

SECRETARIA MUNICIPAL DE PLANEJAMENTO, GESTÃO E MOBILIDADE
planejamento@araras.gov.br - (19) 3547 3053

SECRETÁRIO: ARQUITETO FELIPE DEZOTTI BELOTO

DATA REVISÃO: _____

ESCALA: Indicada

FOLHA: 1/2